

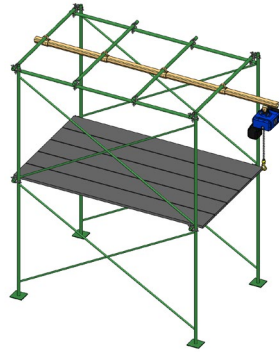

TECHNICAL DESCRIPTION of Scaffolding Runways



Contact Us

Tel: 0808 123 69 69
Fax: 0117 9381 602
email: sales@safetyliftinggear.com

Unit R1D Rockingham Gate
Cabot Park
Poplar Way West
BRISTOL
BS11 0YW

index

TECHNICAL DESCRIPTION of Scaffolding Runways

1. SYSTEM OVERVIEW

- 1.1 Standard System Characteristics
- 1.2 General Information
- 1.3 Industry Standards
- 1.4 Certification and Conformity
 - 1.4.1 CE Certification
 - 1.4.2 EC Declaration of Conformity
 - 1.4.3 Manufacturers Certificate
- 1.5 Fall Arrest Application

2. COMPONENTS

- 2.1 Component List
- 2.2 Track Sizes

3. SYSTEM DESIGN

- 3.1 SWL and Load Trolley Section
- 3.2 Track Layout Design
 - 3.2.1 Track Lengths
 - 3.2.2 Support Centres
 - 3.2.3 Track and System Weight
- 3.3 Joint Supports
- 3.4 Intermediate Supports
- 3.5 End Stops and Ultimate Stop Cross Bolts
- 3.6 Cantilevers

4. INSTALLATION

- 4.1 Pre-Installation Checks
- 4.2 Intermediate Supports
- 4.3 Joint Supports
- 4.4 Load Trolley
- 4.5 End Stop and Ultimate Stop Cross Bolts
- 4.6 Marking

5. MAINTENANCE AND TESTING

- 5.1 Inspection Guidelines
- 5.2 Operational Warnings
- 5.3 Testing within Initial Thorough Examination
 - 5.3.1 Testing according to BS 2853 : 2011
 - 5.3.2 Testing according to BS EN 16851 : 2017
- 5.4 Testing within subsequent Thorough Examinations
- 5.5 Things to look for within Thorough Examination
 - 5.5.1 Track opening tolerance
 - 5.5.2 Maximum wear of Track Material
 - 5.5.3 End Stops and Ultimate Stop Cross Bolts
 - 5.5.4 Maximum wear of Bearings Diameter on Trolleys

6. PREVIOUS SYSTEM DESIGNS

- 6.1 Pre-Installation Checks
 - 6.1.1 Obsolete Components
 - 6.1.2 Installation Differences
 - 6.1.3 Required Modifications
- 6.2 Changes to Part Numbers
- 6.3 Changes to the SWL of Load Trolleys
- 6.4 Change of drilling location for 27 Ultimate Stop Cross Bolt Holes
- 6.5 Do not use unidentified Components

1 SYSTEM OVERVIEW

1.1. Standard System Characteristics

SWL (kg)	NIKO Profile	Support Centres (m)	Trolley Type
100	24.000	1.5	24.T48
250	25.000	1.5	25.T48
500	26.000	1.5	26.T48
1000	27.000	1.5	27.T48
1600	27.000	1	27.T24
2000	27.000	0.75	27.T49

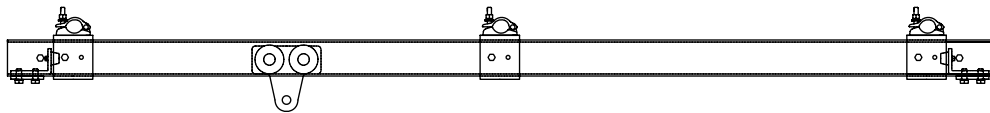

Figure 1.1.1 – System with single section of track

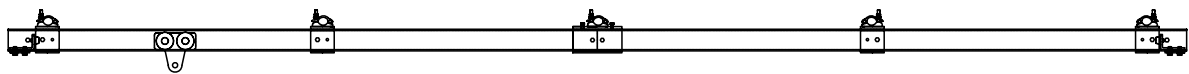

Figure 1.1.2 – System with multiple track sections connected with a joint support.

1.2. General Information

- NIKO Scaffolding Runway Systems utilise the NIKO C1 Conveyor Systems range of components.
- The runway system connects directly to scaffolding poles.
- It enables the movement of heavy items around a scaffolding structure.
- Manual and electric hoists can be used in conjunction with the system to facilitate lifting.
- Its modular design incorporates straight lengths, curves, and switches so that it can be designed to accommodate a wide range of applications.
- All components supplied by NIKO Ltd conform to our quality systems and specification as detailed in NIKO Conveyor Systems and Light Crane technical catalogues.

1.3 Appropriate Standards

Equipment has been engineered in accordance with BS EN 16851 Light Crane Systems and BS 2853 specification for the testing of steel overhead runways for hoist blocks.

1.4. Certification and Conformity

1.4.1 Scaffolding Runway Systems are CE certified

1.4.2 Load trolleys are supplied with an EC Declaration of Conformity.

1.4.3 A Manufacturers Certificates can be supplied for all other components upon request.

1.5 Fall Arrest Application



Some 25 series components are certified to EN795 for fall arrest applications. The system must be installed to "NIKO" F1 Fall Arrest Systems guidelines (not detailed in this document), which is freely available from NIKO Ltd.



Do not attempt to use a Scaffolding Runway System for this application without seeking technical advice.

2 COMPONENTS

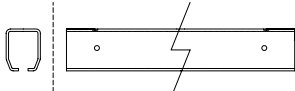
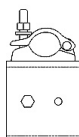
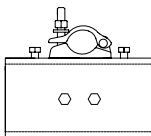
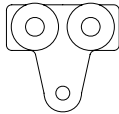
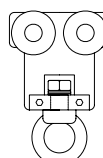
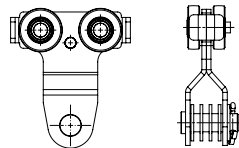
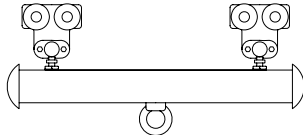
2.1. Component List

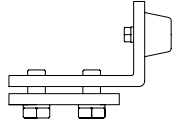
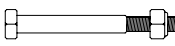
Part Number	Description	Image
xx.000-3-SCF (*)	3m Track Length	
xx.B81 (**)	Intermediate Support	
xx.B80 (**)	Joint Support	
xx.T10	Load Trolley with Hole (see Table 3.1 for SWL)	
xx.T40	Load Trolley with Rotating Eye (see Table 3.1 for SWL)	
xx.T48	Load Trolley with Clevis Pin (see Table 3.1 for SWL)	
xx.T24	Double Load Trolley with Eye (see Table 3.1 for SWL)	
xx.T49	Double Load Trolley with Clevis Pin (see Table 3.1 for SWL)	
xx.X01	End Stop	
xx.X01-xx-xxx	Ultimate Stop Cross Bolt	

* The number "3" denotes the length of track. Other track lengths will have a different number relating to their length in metres.

** These items were previously referred to with another part number. See section 6.2 for further details on this.
Note: Other component information (e.g. bends, switches and turn tables) is available upon request.

2

2.2 Track Sizes

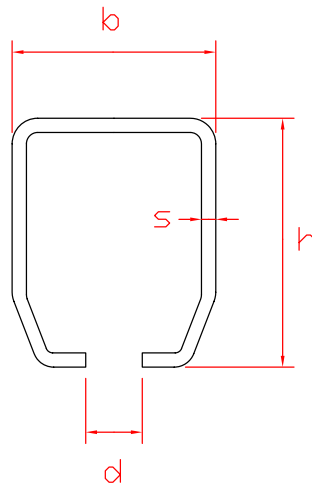

Track Profile	Dimensions				Wheel Diameter (mm)
	h (mm)	b (mm)	d (mm)	s (mm)	
24.000	43.5	48.5	15.5	3.2	35
25.000	60	65	18.5	3.6	42.5
26.000	75	80	22	4.5	54
27.000	110	90	25	6.5	60



NOTE:

Components from different profile ranges are not compatible.

3

SYSTEM DESIGN

3.1. Load Trolley

Determine the Safe Working Load (SWL) or Working Load Limit (WLL) that is required from the scaffolding runway system. Then select a suitable load trolley for the SWL from this table:

LOAD TROLLEYS					
NIKO profile	SWL				
	xx.T10	xx.T40	xx.T48	xx.T24	xx.T49
24.000	80kg	80kg	125kg	160kg	250kg
25.000	200kg	200kg	250kg	400kg	500kg
26.000	400kg	400kg	500kg	800kg	1000kg
27.000	800kg	800kg	1000kg	1600kg	2000kg

3

3.2. Track Layout Design

Determine how many track sections are required to assemble a complete system. Consider the total system length, length of each track section, location of support points and weight of each track section.

3.2.1 Track Lengths

Track is usually supplied in 3m and 6m sections. Non-standard track lengths are available upon request from NIKO Ltd. Track Lengths can be joined together to make a complete system of any length.

3.2.2 Support Centres

Calculate the maximum support centre distance, based upon the SWL using the graph below.



NOTE:
0.75m, 1m, 1.5m support centres work best with standard 3m track lengths.

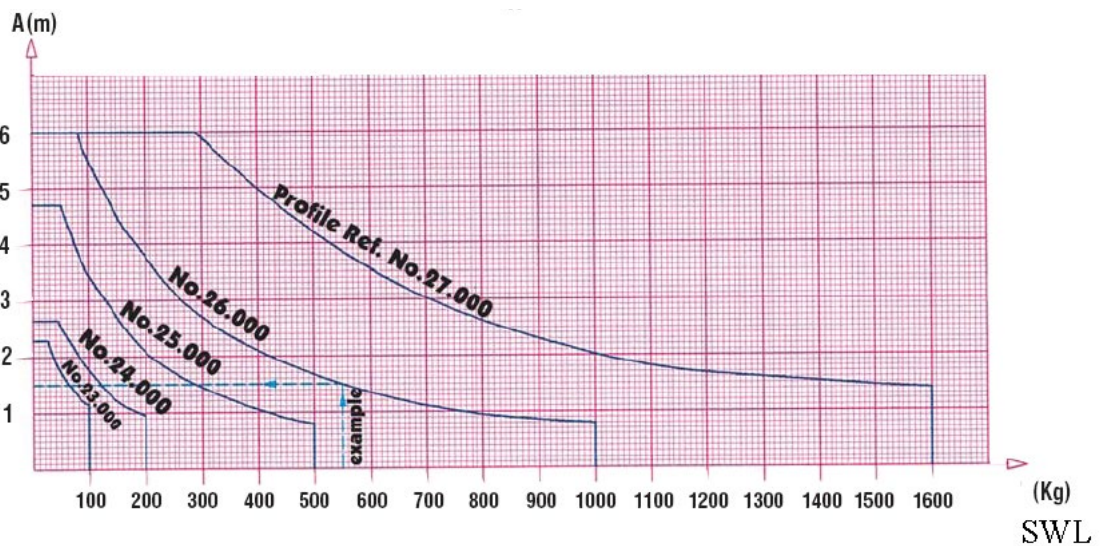
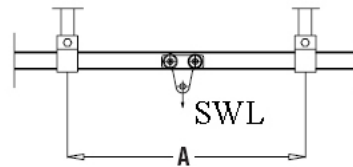

3.2.3 Track and System Weight

Weight should be considered for handling and installation purposes.

NIKO Profile	Track Weight / mtr	System Weight /mtr *
24.000	3.59kg	5.11kg
25.000	5.62kg	7.92kg
26.000	8.72kg	12.59kg
27.000	16.38kg	23.68kg

* Based on 3m track lengths and 1.5m support centres

3

3.3 Joint Supports

Required to join the Track Lengths in systems with multiple Track Lengths. Calculate the quantity of Joint Supports using this formula:

$$\text{Number of Joint Supports} = \text{Number of Track Lengths} - 1$$

3.4 Intermediate Supports

Required to support a system at every support centre, excluding those supported by Joint Supports. Calculate the quantity of Intermediate Supports using this formula:

$$\text{Number Intermediate Supports} = [(L / S) + 1] - J$$

L = Total Length of System in metres
S = Support Centre Distance in metres
J = Number of Joint Supports

3.5 End Stops and Ultimate Stop Cross Bolts

An End Stop and an Ultimate Stop Cross Bolt are required at every open end of the system. These are to ensure that load trolleys can never leave the end of a system. This is a mandatory safety feature.

3

3.6 Cantilevers

Track cantilevers can be achieved, providing the system is supported correctly from a minimum of two fixed support points. Use the table below to calculate the maximum allowable cantilever for a system design.

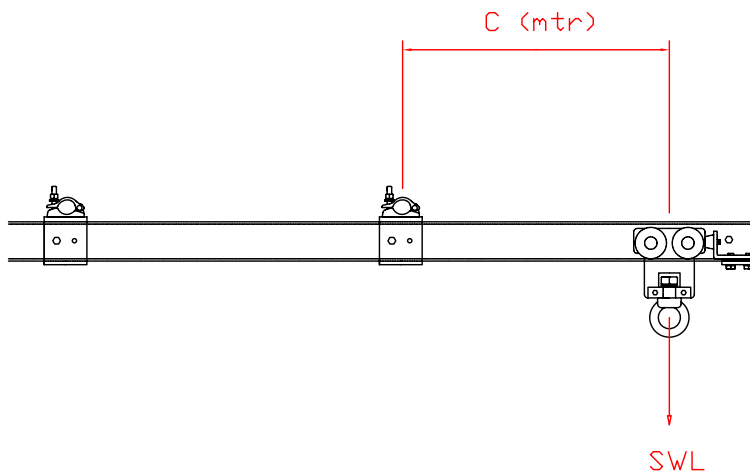

Track Profile	Maximum Allowable Cantilever
24.000	$C * SWL < 45\text{kg.m}$
25.000	$C * SWL < 100\text{kg.m}$
26.000	$C * SWL < 250\text{kg.m}$
27.000	$C * SWL < 500\text{kg.m}$

i NOTE: Cantilever length C should never exceed 1m

4

INSTALLATION

4.1. Pre-Installation Checks

- i) Ensure there are enough components to assemble a complete system.
See System Design (ref: 3) if unsure.
- ii) Ensure the scaffolding design is strong enough to support the runway system weight and has enough support points to suspend it from.
Support point loadings can be supplied upon request.
- iii) Ensure that the system will be fitted onto a level scaffolding structure.

4.2 Intermediate Supports

Scaffold Clip

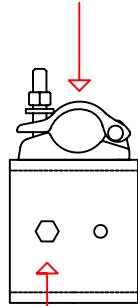

Side Bolts

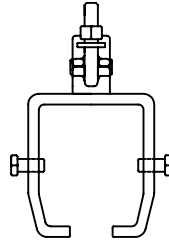

STEP 1. Position the Intermediate Supports on the Track Length(s) at the required support points.

STEP 2. Lift the Track Length(s) into position, on the scaffolding structure.

STEP 3. Fasten the scaffold clip part of the Intermediate Supports around the scaffolding poles and tighten its bolt securely between 40-80Nm.

STEP 4. Use the side bolts (one on either side) to pinch the track into a central position.

Tighten these bolts to approximately 7Nm, do not over tighten the pinch bolts, as this will cause the Intermediate Supports to open up.

4.3 Joints Supports

In systems with multiple Track Lengths use the Track Joints to join the Track Lengths together.

Scaffold Clip

Top Bolts

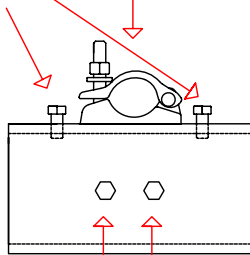

Side Bolts

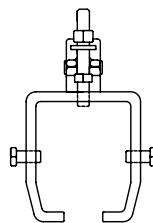

STEP 1. Position the scaffolding clip part around the support poles and fasten its bolt securely between 40-80Nm.

STEP 2. Slide the track lengths into each end, so that they meet in the middle.

STEP 3. Locate the top bolts into the grooved hole in the top of the Track Lengths and fasten into place. Tighten these bolts to approximately 10-12Nm, do not over tighten as this may cause damage to the track.

STEP 4. Use the side bolts to align the track inside the joints. They are not to be used for clamping or locking, as over tightening will cause the track running slot to close up.

STEP 5. It is sometimes necessary to file a small chamfer on the running edge of the Track Lengths, this will enable the trolley to run through the Joint Supports more smoothly.

4.4 Load trolley

The Load Trolley(s) can be placed into the system once the Track Length(s) are fully secured and installed in accordance with steps 4.1 to 4.3.

4.5 End Stop and Ultimate Stop Cross Bolts

End Stops and Ultimate Stop Cross Bolts must be fitted into every open end of the system.

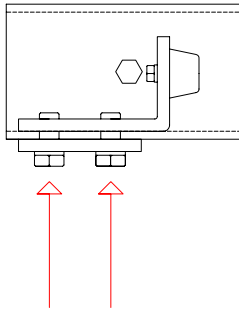

Locking Bolts

End Stop	Torque
24.X01	30-40Nm
25.X01	30-40Nm
26.X01	40-50Nm
27.X01	40-50Nm

STEP 1. Once the End Stops are positioned fully in the track, they must be tightened using the two locking bolts to the torque figures below.

STEP 2. The Ultimate Stop Cross Bolts should be positioned behind the End Stops into pre-drilled holes. Tighten the nyloc nut to approximately 10Nm. If necessary, drill the Track Length(s) in order to fit these as they are a critical safety feature. The track should be drilled as follows:

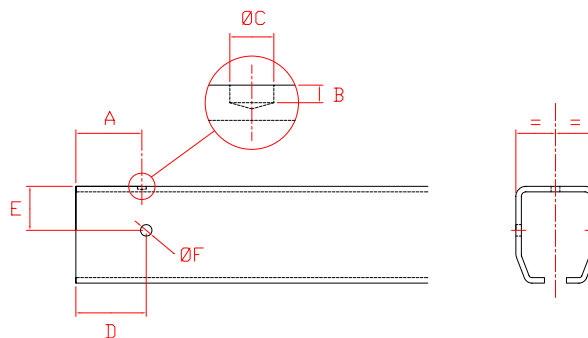

Profile Track	A (mm)	B (mm)	ØC (mm)	D (mm)	E (mm)	ØF (mm)
24.000	55	1.75	10	65	20	9
25.000	71	2	10	75	25	11
26.000	70	2	12	80	30	13
27.000	75	3	14	80	55	13



Under normal working conditions the Ultimate Stop Cross Bolt should be replaced every 12 months, however it must be replaced immediately if it is damaged. The nyloc nut must be replaced every time the Ultimate Stop Cross Bolt is changed.

4.6 Marking

After a system has been installed it must be clearly marked with the following:

- **SWL** (Safe Working Load) or **WLL** (Working Load Limit).
- **Name of manufacturer** (whoever is responsible for combining the scaffolding runway with the supporting structure and lifting device).
- **Identification number for the runway.**
- **Year of manufacture.**
- **Maximum hoisting speed** for powered hoists or else the words '**Manual Hoists Only**'.



These markings are a statutory requirement.



Note: NIKO Ltd SWL stickers are available to purchase upon request.

5

MAINTENANCE AND TESTING

5.1. Inspection Guidelines

LOLER Lifting Operation and Lifting Equipment Regulations 1998 must be followed. These are our recommended maintenance guidelines:

PART	After Installation	Weekly	Every 6 Months
Track Lengths			
Intermediate Supports	(i) Ensure every component has a valid Manufacturers Certificate, EC Declaration of Conformity or Certificate of Thorough Examination.		
Joint Supports		A scaffold based system; visual inspection must be carried out (as a minimum).	Thorough Examination of all track and components for deformation, wear and loose connections.
Load Trolleys	(ii) A suitably qualified person must carry out a Thorough Examination in accordance with LOLER after every installation and reinstallation.		
End Stops & Ultimate Stop Cross Bolts			

Table: Table of actions for maintenance

5.2 Operational Warnings



1. Any changes in normal working or any abnormal noises must be immediately found and corrected.
2. If trolleys do not run freely and smoothly throughout the whole system, then they must be taken out of service immediately and investigated.
3. Never lubricate the track or trolleys, as this may cause travelling resistance resulting in premature wear or damage to the bearings and track.

5.3 Testing within initial Thorough Examination

The following tests must be carried out by a competent person as part of the initial Thorough Examination before a Scaffolding Runway System can be put into service after installation or re-installation onto a support structure.

5.3.1 According to BS2853 : 2011 the following tests are required:

- Deflection test @ SWL
 - Maximum allowable deflection at SWL:
 - 1/300th of span between support points
 - 1/200th of the cantilever length (25, 26 and 27 series only)
- Proof load test @ 125% SWL

5.3.1 According to BS2853 : 2011 the following tests are required:

- Function test
- Static test @ 125% SWL
- Dynamic test @ 110% SWL

5.4 Testing within subsequent Thorough Examination

Testing (on the same installation) after the initial Thorough Examination is always at the discretion of the competent person and should be used to supplement the Thorough Examination.

5.5 Things to look for within a thorough examination

5.5.1 Track opening tolerance +/- 1mm at the centre span

Profile	Track Opening Width
24.000	15mm
25.000	18mm
26.000	22mm
27.000	25mm

5.5.2 Maximum of 10% wear of the track material thickness

Profile	Track Thickness
24.000	3.2mm
25.000	3.6mm
26.000	4.5mm
27.000	6.5mm

5.5.3 Maximum of 10% wear of the trolley body material thickness

Trolley	Trolley body thickness
24.T48 / 24.T10 24.T40	8mm 6mm
25.T48 / 25.T10 25.T40	10mm 8m
26.T48 26.T10 / 26.T40	12.3mm 12mm
27.T48 27.T10 / 27.T40	16mm 15mm



5.5.4 Maximum of 0.7mm wear of the bearing wheel diameter on trolleys

Trolley	Bearing Wheel Diameter
24.Txx	34mm
25.Txx	48mm
26.Txx	59mm
27.Txx	89mm

6 PREVIOUS SYSTEM DESIGNS

6.1 Pre 15/08/2009 Design

6.1.1 Obsolete components

Ref	Part Number	Description	Image
6.1.1.1	xx.000-3-SCF	Track Length without Drilled ends and Location Holes	
6.1.1.2	xx.000-B49-SCF	End Track Length with Welded Joint Support	

6.1.2 Installation differences

- i) Every system must start and end with an End Track Length (ref: 6.1.1.2).
- ii) End Track Lengths are fitted like ordinary Track Lengths, however the welded joint supports end needs to be located so that its scaffolding clip can clamp around a supporting scaffold pole.
- iii) There are no grooved holes to locate the Track Lengths, so the top bolts in the Joint Supports are used to push the track down and create a flat running surface instead.

6.1.3 Required modifications

All Track Lengths (6.1.1.1) are drilled to suit latest system design. Drilling dimensions are shown in this document (ref: 4.5).

6.2 Changes to Part Numbers

Current Part Number	Previous Part Number
xx.B80	xx.B49-SCF
xx.B81	xx.B50-SCF
xx.000-3-SCF	xx.000

6.3 Changes to Safe Working Load of Trolleys

Part number	Current SWL	Previous SWL
24.T10	80kg	125kg
24.T40	80kg	125kg
25.T10	200kg	250kg
25.T40	200kg	250kg
26.T10	400kg	500kg
26.T40	400kg	500kg
27.T10	800kg	1000kg
27.T40	800kg	1000kg

The change was to bring the SWL in line with other NIKO product ranges.



Trolleys with the old SWL rating can still be used, providing they have a relevant Certificate of Thorough Examination or EC Declaration of Conformity specifying the previous SWL.

6.4 Change of drilling location for 27 Ultimate Stop Cross Bolt Holes

The height of this was lowered, to ensure that it would still function, if used in conjunction with 26.X01 End Stop instead of 27.X01 End Stop.

6.5 Do not use unidentified Components

Do not use any components other than those detailed in this document.
Contact NIKO Ltd for further guidance on this issue.